

## BOUNDARY CONDITIONS IN SCALE MODELLING OF AIRFLOW IN LARGE VENTILATED ROOMS

Maria HURNIK\*

\* Dr.; Faculty of Energy and Environmental Engineering, The Silesian University of Technology,  
Konarskiego 18A, 44-100 Gliwice, Poland  
E-mail address: [maria.hurnik@polsl.pl](mailto:maria.hurnik@polsl.pl)

Received: 3.03.2011; Revised: 15.03.2011; Accepted: 19.04.2011

### Abstract

Scale model experiments make it possible to analyse design concepts of ventilation, especially air distribution in large rooms. The airflow structure similarity is fulfilled when experiment is carried out according to the principles of the approximate scale modelling. Scale modelling of airflow distribution in large enclosure requires above all, determination of the conditions necessary to maintain Reynolds number independence of the mean flow, as well as defining ways in which the flow turbulent structure could be simulated. Special attention should also be paid to proper simulation of boundary conditions. In a real ventilated object, the air is supplied with standard diffusers equipped with deflecting vanes. The question is how the supply opening should be constructed in the model to ensure the airflow similarity in the whole space modelled.

The paper presents the results of experimental analyses of air velocity fields in scale models in the range of Reynolds number at the outlets from 1 850 to 98 000. The field maps of air velocity mean value were tested. Turbulence energy spectra in the model flows were analysed at the corresponding points of models. The threshold Reynolds number, which makes it possible to maintain approximate similarity of mean velocity distribution in the whole modelled space was identified. The tests show that it is possible to maintain similarity of turbulence spectrum in scale models when a second threshold Reynolds number is exceeded. The paper also presents the results of experimental tests of supply jets generated by a standard diffuser and circular openings. An omnidirectional thermoanemometer was used for the air mean velocity measurements. The origin position of jets and velocity distribution coefficient were determined. A method for supply air jet reproduction in models is suggested. Satisfactory similarity of the mean velocity field in the modelled jets was acquired when real diffusers were simulated in the models by circular openings fitted with turbulizers and when the jet origin was properly positioned.

### Streszczenie

Eksperyment fizykalnego modelowania umożliwia analizę projektowych koncepcji wentylacji, zwłaszcza rozdziału powietrza, w dużych pomieszczeniach. Podobieństwo struktury przepływu jest spełnione jeśli badania prowadzone są zgodnie z zasadami przybliżonego modelowania fizykalnego. Modelowanie fizykalne przepływu powietrza w dużych pomieszczeniach wymaga przede wszystkim określenia warunków niezbędnych do utrzymania w modelu niezależności średniego przepływu powietrza od liczby Reynoldsa a także określenia sposobu symulacji turbulentnej struktury przepływu powietrza. Szczególną uwagę należy również zwrócić na poprawną symulację warunków brzegowych. W rzeczywistych obiektach powietrze wentylacyjne dostarczane jest przez standardowe nawiewniki wyposażone w łopatki kierujące. Należy również zbadać jak powinny być skonstruowane nawiewniki w pomniejszonym modelu fizykalnym, tak aby zapewnić podobieństwo przepływu powietrza w całej modelowanej przestrzeni.

Artykuł przedstawia wyniki eksperymentalnych badań pól prędkości w modelach fizykalnych w zakresie wartości liczby Reynoldsa w otworach nawiewnych od 1 850 do 98 000. Analizie poddano mapy pól średniej prędkości powietrza. W odpowiadających sobie punktach modeli fizykalnych, o różnej skali porównano również spektra energii turbulencji ruchu powietrza. Zidentyfikowano wartość progową liczby Reynoldsa, powyżej której zachowane jest przybliżone podobieństwo rozkładu średniej prędkości, w całej modelowanej przestrzeni. W artykule przedstawiono również wyniki pomiaru pól prędkości średniej w strugach nawiewanych generowanych przez standardową kratkę wentylacyjną i kołową dyszę, pomiary wykonano za pomocą wielokierunkowych termoanemometrów. W badanych strugach wyznaczono położenie bieguna oraz współczynnik rozkładu pola średniej prędkości. Zaproponowano sposób odwzorowywania w modelach strug nawiewanych. Zadawalające podobieństwo pól prędkości w strugach nawiewanych uzyskano modelując rzeczywistą kratkę nawiewną za pomocą otworu kołowego wyposażonego w turbulizator przepływu, przy uwzględnieniu położenia bieguna strugi.

Keywords: Airflow in room; Scale modelling; Reynolds number; Diffuser modelling.

## 1. INTRODUCTION

The principles and methods of scale modelling in ventilation aerodynamics already have many year tradition although computational fluid dynamic (CFD) simulations of airflow in rooms are more and more commonly used [1, 2]. Scale model experiments are still considered as wanted and useful tool in a ventilation design process especially of air distribution in large rooms.

The airflow similarity in reduced scale models is fulfilled when experiment is carried out according to the principles of the approximate scale modelling. Scale modelling of airflow distribution in large enclosure requires above all, determination of the conditions necessary to maintain Reynolds number independence of the mean flow, as well as defining ways in which the air diffusers could be simulated.

Approximate modelling method assumes that similarity for the air mean velocity field can be fulfilled when flows in the real object and in its scale model are fully turbulent and Re-number independent.

Such an assumption means that in a system of the modelled physical phenomena, the effect of the viscosity is neglected.

Improvement in scale modelling methods requires, above all, precisizing the conditions necessary to maintain Reynolds number independence of the flow in the model, as well as characterizing conditions of the flow turbulent structure similarity. It might be required in some modelled ventilation cases, e.g. when predicting air change efficiency or characterizing irregularities of the air flow fields in a ventilated object which are caused by space limit in the room and flow instability of the ventilation system.

However, what does “fully turbulent flow” mean in practice? When turbulence develops at larger Re-number, the flow field becomes asymptotically similar and Re-number independent. It becomes no longer valid and flows become self-modelling. Thus, a certain Re value ought to be assumed above which the turbulence of the flow may be considered sufficiently developed in the aspect of Re-number independence. Such a value is defined as threshold

Dimensions in mm	Model scale			
	1:10	1:5	1:1,75	1:1
Length $A$	2 700	-	-	27 000
Width $B$	1 500	3 000	8 570	15 000
Height $H$	550	1 100	3 150	5 500
Height of the supply openings $H_1$	298.5	597	1 720	2 985
Supply openings $a \times b$	90×3	180×6	514×17.2	900×30
Supply openings diameter $\phi$	18.4	37.5	105.8	184

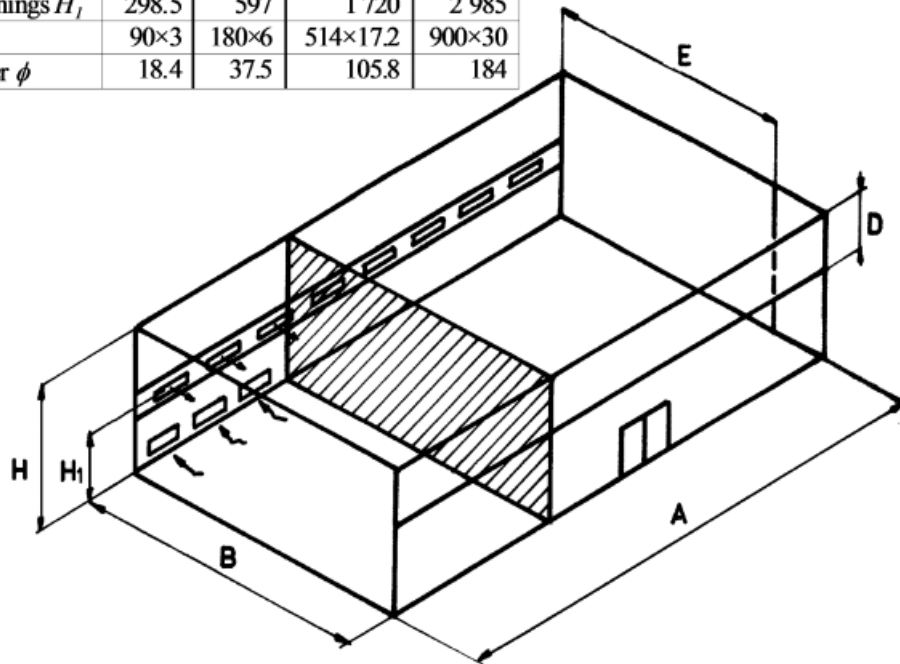

Figure 1.  
The sports hall dimensions and arrangement of supply openings

Reynolds number,  $Re_l$  [3, 4]. In the approximate physical scale modelling method it is sufficient to fulfill the following similarity conditions on the full-scale object and (Ob) and its scale model (M):

$$Re_M > Re_l \quad Ar_M = Ar_{Ob} \quad Pr_M = Pr_{Ob} \\ (GrPr)_M > (GrPr)_l$$

Thus, only  $Ar$  number is left as the similarity criterion. Taking into account the equality of Archimedes numbers, velocity scale is calculated from the equation:  $S_W = (S_L S_{\Delta T})^{0.5}$  where  $S_W$ ,  $S_L$ ,  $S_{\Delta T}$  are velocity, length and temperature difference scales, respectively.

Apparently, the assumption of the flow independence of  $Re$ -number limits the modelling area to the region where  $Ar$  criterion is fulfilled and  $Re_l$  number kinetically controls the boundary conditions.

To properly apply the method of approximate scale modelling in ventilating air distribution tests, the following are of great importance:

- choice of threshold  $Re_l$  number, by which the error of the approximate modelling method, model construction dimensions and velocity measurement accuracy are affected
- good knowledge of ventilating flow structure evolution in models, necessary to decide whether turbulent flow, contributing to pollutant propagation and thermal comfort conditions in the room, can be modelled
- the knowledge how the supply opening should be constructed in a model so that the airflow similarity will be ensured.

## 2. ANALYSIS OF MEAN FLOW SIMILARITY CONDITIONS IN MODELS

The experiments included:

- determination of threshold Reynolds number,  $Re_l$ , in order to characterize the lower limit of the mean flow self modelling interval,
- tests of similarity of mean velocity distributions in the whole region of air flow pattern modelling in room.

In order to explain these problems, measurements were carried out to make a comparative analysis of the mean flow velocity fields possible:

- in one model, at different  $Re$  numbers and different supply velocities
- in models of different sizes at the same (or similar)  $Re$  numbers.

The tests were carried out in three similar scale models of a sports hall: small (1:10), medium (1:5) and large (1:1.75), see Fig. 1.

Reynolds numbers varied from 1 850 to 98 000 and supply velocity varied from 1.5 to 15 m/s. Velocity distributions were measured in the plane including the axis of one of the supply openings. An eight-channel omnidirectional thermoanemometer was used for the air velocity measurements. The sensors were carefully calibrated before measurements within the velocity range from 0.03 m/s to 5 m/s. Uncertainty of mean velocity measurement using this type of thermoanemometer is  $0.025 + 0.025 \cdot W$  m/s [5]. The velocity maps in the models are shown in Figures 2 and 3. When analysing the velocity maps in the separate models (shown in Figures 2 and 3) small (S), medium (M) and large (L), respectively, the following regularities can be observed:

1. At different  $Re$  numbers in the same model similarity of mean velocity distributions and the  $Re$ -number independence are observed, in respect both to the supply jet region especially jet throw length and to secondary flow region observing the level of air velocity in occupied zone. But the degree of the flow similarity varies:
  - at sufficiently high  $Re$  numbers, above 8 000-10 000, similarity may be defined as good,
  - at  $Re$  numbers decreasing from 8 000-3 500 similarity worsens gradually; discrepancies get apparent at  $Re$  numbers lower than 2 000, particularly in the secondary flow region.
2. Taking the above into account the threshold  $Re$  number value,  $Re_l$  may be assumed for approximate ventilation modelling as about  $Re_l = 4 000$ .

## 3. TURBULENCE SIMILARITY IN PHYSICAL SCALE MODELS OF VENTILATION

The analysis of velocity fluctuation frequency spectrum gives information about the spatial structure and time run of the turbulence evolution. The turbulent movement is presented as superposition of eddies of various dimensions and time scales.

Relatively little is known about the turbulence structure of ventilating air flows in rooms. The results of measurement of the spectrum and turbulence scales in different points of the ventilated room are presented by *Etheridge* and *Sandberg* [6] and by

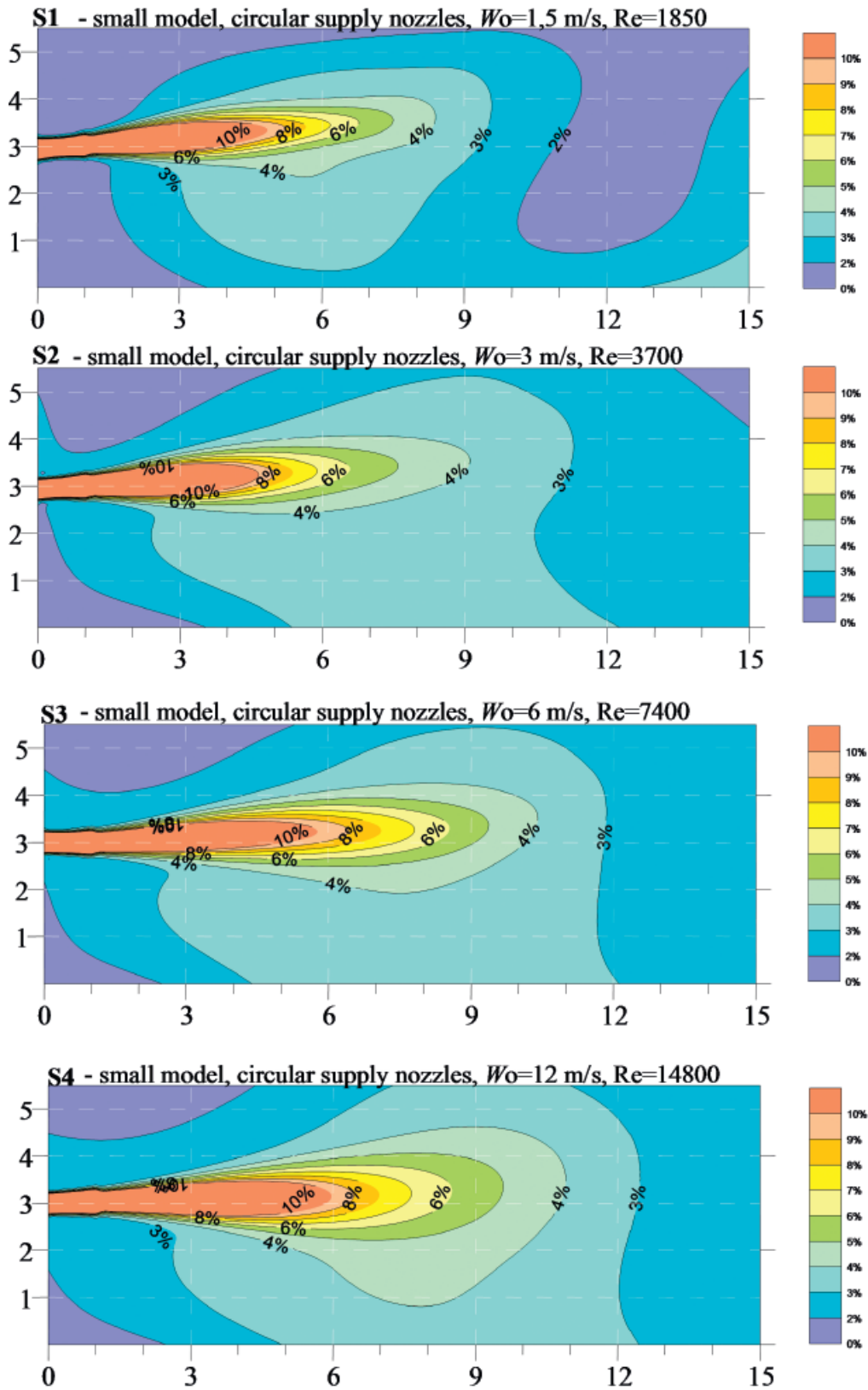

Figure 2. Maps of normalized mean velocities isolines in the small model at  $Re = 1850$  to  $14800$ ,  $W_o=1.5$  to  $12$  m/s



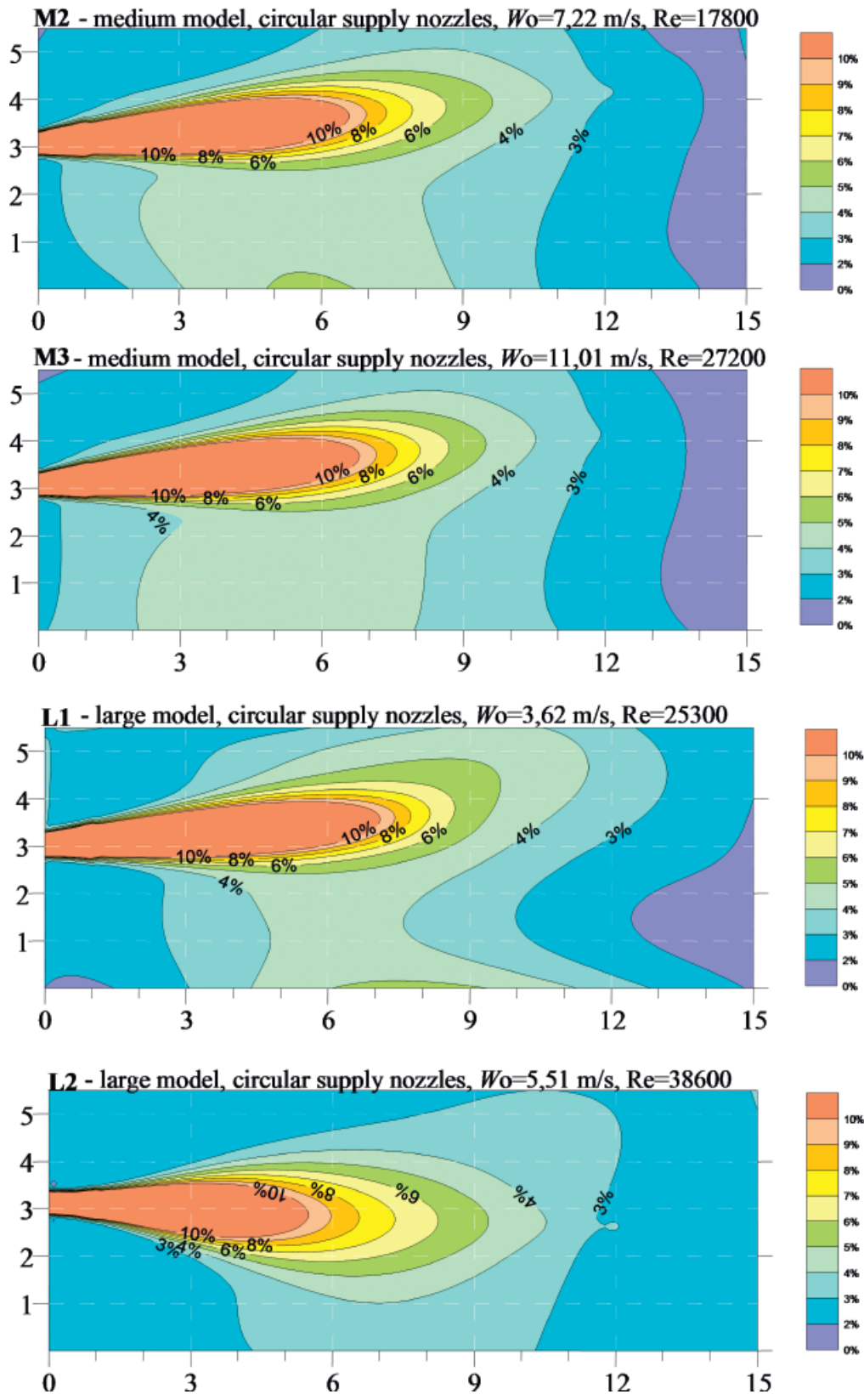

Figure 3. Maps of normalized mean velocities isolines in medium and large models at  $Re = 17\ 800$  to  $38\ 600$ ,  $W_o = 3.62$  to  $11.01$  m/s

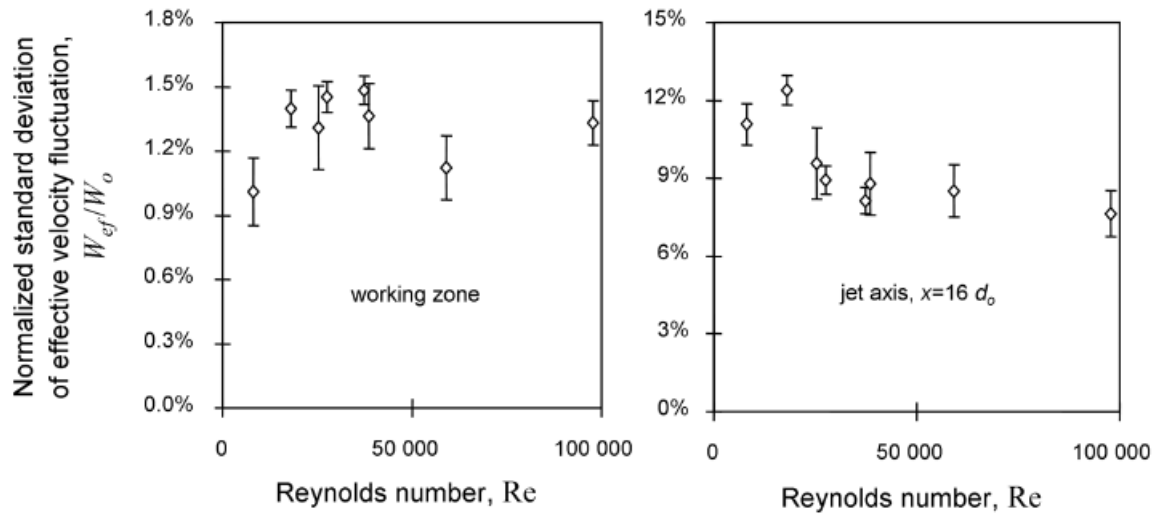

Figure 4. Similarity of total turbulence energy in selected points of the ventilated room, normalized standard deviation of effective velocity fluctuation  $W_{ef}^*/W_o$  as a function of Reynolds number  $Re$

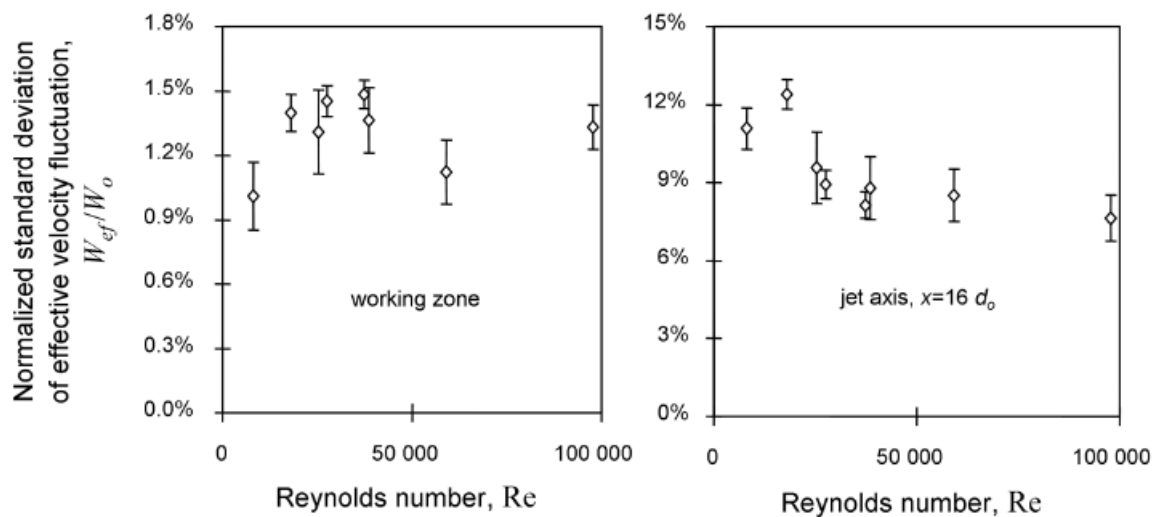

Figure 5. Normalized turbulence spectrum  $E(f)/W_o d_o$ , in a supply jet and working zone of the ventilated room scale model as a function of dimensionless frequency  $f \tau_o$ .

Finkelstein et al. [7]. It was found that turbulent velocity fluctuations in the occupied zone occur only in the range of frequencies up to 2 Hz. There is lack of publications including more detailed analysis. The problem of the air flow turbulence similarity in ventilated rooms is hardly recognized. Only Soehrich [8] presented some results of turbulent shear stress measurement in scale models of a ventilated room and ascertained that the stresses get stabilized when Reynolds number is higher than 10 000.

In the present measurements a constant temperature hot wire thermoanemometer was used for instantaneous velocity measurement. The signal was sampled

for 10 min with the sampling frequency 60 Hz. The measurements were made in 2 models of scales 1:5 and 1:1.75. The air was supplied with different velocities varying from 3 to 15 m/s. The RMS value of velocity fluctuations  $W_{ef}^*$ , and spectral function of turbulence,  $E(f)$ , were determined from the analysis of instantaneous velocity values.

The measure of total turbulence energy is either RMS value or velocity fluctuation variance. Similarity may be analysed by assuming the mean velocity value in the supply opening,  $W_o$ , as scale velocity and the supply opening diameter,  $d_o$ , as scale linear dimen-

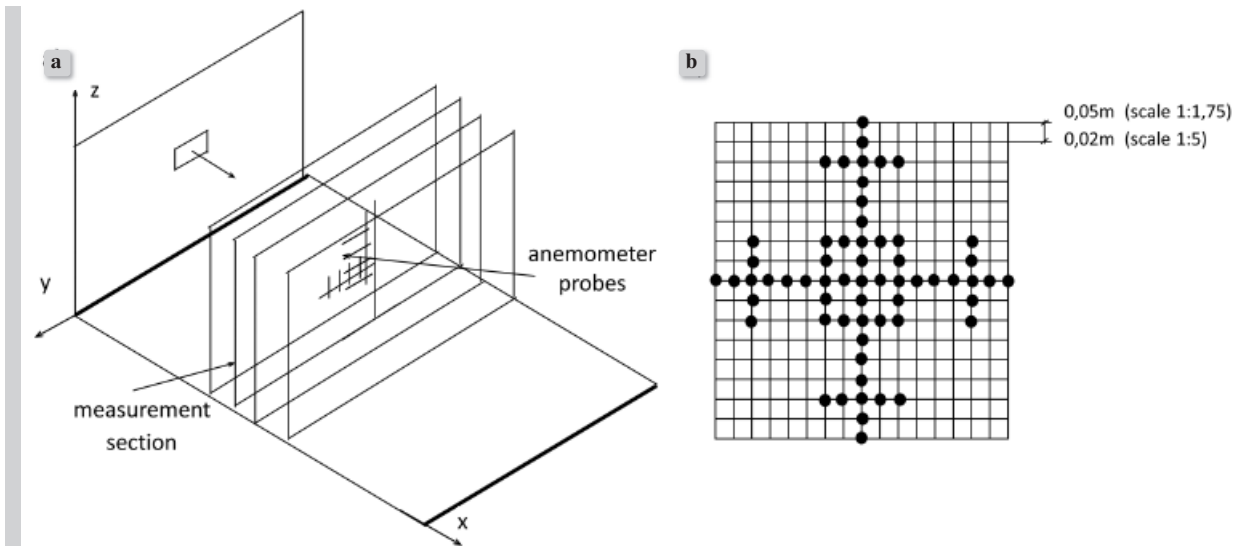

Figure 6.  
a) The measurement stand, b) The grid used in the tests of jets

sion. Similarity of total turbulence energy was estimated on the basis of the ratio  $W_{ef}^*/W_o$ , depending on Reynolds number. The results are shown in Fig. 4.

It is observed that for Reynolds numbers from the range tested i.e. 8 000-98 000 the ratio  $W_{ef}^*/W_o$  changes within the range  $1 \div 1.5\%$ , in the working zone whereas in the supply jet, at the distance from the outlet  $x=16d_o$  in the range 7.6-12.4%. It means that in the abovementioned Reynolds number range similarity of the total turbulence energy occurs with the accuracy of the order of  $\pm 25\%$ . Apparently the ratio  $W_{ef}^*/W_o$  value increases in the supply jet for  $Re < 20\ 000$  and decreases in the working zone for  $Re < 10\ 000$ . The reasons for such changes may be explained when observing the turbulence spectrum in Fig. 5.

Similarity of turbulence spectrum was analysed after having normalised the power spectral density function of velocity fluctuation  $E(f)$ . The spectrum  $E(f)$  was divided by  $W_o 2\tau_o$  i.e. by  $W_o d_o$ , dimensionless frequency was introduced by multiplying frequency by the time scale  $\tau_o = d_o/W_o$ . The results obtained show that for  $Re > 20\ 000$  similarity of turbulence spectrum occurs within the whole frequency range. For  $Re < 20\ 000$  it may be observed that large scale turbulent eddies appear in the supply jet and the spectrum gets limited in the working zone. The lack of turbulence spectrum similarity for  $Re < 20\ 000$  may be explained by more intense effect of secondary flows on the supply jet and by limiting the cascade transformation of large-scale eddies to dissipating structure in the working zone.

#### 4. TESTS OF JETS FROM CIRCULAR OPENINGS AND STANDARD DIFFUSERS

The experiments included:

- Tests of jets from circular openings and standard diffusers in order to determine the difference in the jet mean flow patterns (standard diffuser in scale 1:1.75, circular openings in scale 1:1.75, 1:5)
- Simulation of jets by using circular openings with turbulizers in scale 1:5 instead of standard diffuser models

##### *Description of the measurement stand*

In the tests, based on the mean velocity distribution measurements in the jet, its characteristic parameters (origin distance, velocity distribution coefficient) were determined. A scheme of the measurement stand is shown in Fig. 6a. Velocity distributions were measured in four cross-sections of the jet, at the beginning of the jet fully developed region. The distances between the measurement sections were assumed as multiplicity of the supply opening equivalent diameter, i.e.:  $10d$ ,  $15d$ ,  $20d$  and  $25d$ . The scheme of the grid used in the tests is shown in Fig. 6b. An eight-channel omnidirectional thermoanemometer was used for the air velocity measurements. The averaging time was 5 min. Movable systems for simultaneous measurement in eight points of the grid were constructed.

**Analytical procedure for identification of the jet characteristic parameters**

The test results were approximated by a model of a free jet generated by a point source of momentum:

$$\bar{W} = \left( \frac{2 m \dot{I}}{\pi \rho} \right)^{0.5} \frac{1}{x + x_o} \cdot e^{-m \left( \frac{r}{x + x_o} \right)^2} \quad (1)$$

- Where:  $\bar{W}$  – mean velocity
- $\dot{I}$  – momentum flux
- $m$  – velocity distribution coefficient
- $\rho$  – air density
- $x$  – distance from the supply opening
- $r$  – radial distance
- $x_o$  – origin position

In order to identify the jet characteristic parameters:  $\dot{I}$ ,  $m$  and  $x_o$ , the computer optimisation was applied. At first the real actual position of the jet axis was identified. Velocity distributions in two central axes of the measurement grid were approximated by Gaussian curves to find the co-ordinates of the jet axis  $y_a, z_a$ . Then real distances from the jet axis to the measurement points were calculated:

$$r_i = \sqrt{(y_i - y_a)^2 + (z_i - z_a)^2} \quad (2)$$

where:  $y_a, z_a$  – co-ordinates of the jet axis, evaluated separately at each cross-section. Measured velocity

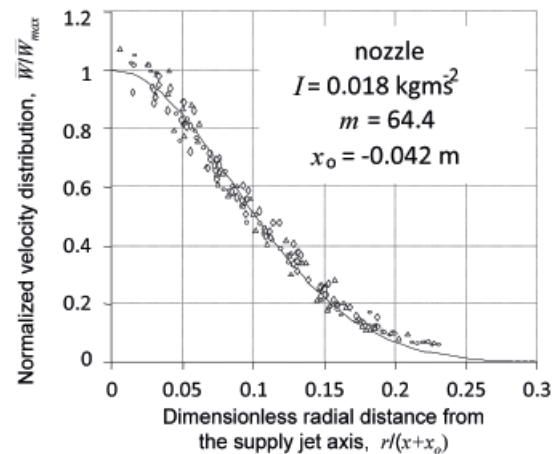

**Figure 7.**  
An example of normalised velocity distribution in a supply jet cross section

values were approximated by the model of jet from point source of momentum using least square method. The value of the approximation error was calculated as:

$$\Delta = \sum_{i=1}^n \delta_i^2 = \sum_{i=1}^n \left[ \frac{\bar{W}_i}{\bar{W}_{max,cal}} - \frac{\bar{W}_{cal}}{\bar{W}_{max,cal}} \right]^2 = \sum_{i=1}^n \left[ \frac{\bar{W}_i}{\left( \frac{2 m \dot{I}}{\pi \rho} \right)^{0.5} \frac{1}{x + x_o}} - e^{-m \left( \frac{r}{x + x_o} \right)^2} \right]^2 \quad (3)$$

Then, the approximation error minimal value was sought by proper selection of  $\dot{I}$ ,  $x_o$  and  $m$  values. An example of the calculations is presented in Table 1. An example of the normalised velocity distribution is shown in Fig. 7. Velocity values lower than 10% of

**Table 1.**  
Example of measurement and calculation results

	$r_i$	$r_i/(x+x_o)$	$\bar{W}_i$	$\frac{\bar{W}_i}{\bar{W}_{max,cal}}$	$e^{-m \left( \frac{r}{x+x_o} \right)^2}$	$\delta_i^2$	
-	m	-	m/s	-	-	-	
1	0.006	0.01793	2.319	0.98324	0.97952	1.4E-05	$\Delta_{min} = \sum_{i=1}^{233} \delta_i^2 = 0.9494$  $\dot{I}  _{\Delta_{min}} = 0.018 \text{ kg}\cdot\text{m}\cdot\text{s}^{-2}$  $m  _{\Delta_{min}} = 64.35$  $x_o  _{\Delta_{min}} = -0.042 \text{ m}$
2	0.014	0.04241	2.159	0.9154	0.8907	0.00061	
3	0.020	0.05985	1.917	0.81287	0.79413	0.00035	
4	0.022	0.06531	1.760	0.74624	0.75997	0.00019	
5	0.026	0.07777	1.364	0.57847	0.67757	0.00982	
6	0.050	0.14913	1.144	0.48510	0.23901	0.06056	
••••	••••	••••	••••	••••	••••	••••	
232	0.132	0.18713	0.122	0.11017	0.10418	3.6E-05	
233	0.137	0.19476	0.116	0.10434	0.10504	4.9E-07	
234	0.148	0.20933	0.098	0.08827	0.09372	3E-05	
235	0.152	0.21485	0.096	0.08639	0.05021	0.00131	
••••	••••	••••	••••	••••	••••	••••	

**Table 2.**  
Velocity profiles widths in jets generated by a nozzle fitted with various turbulizers

Type of turbulizer	Width of the velocity profile $R$ [m]
nozzle without turbulizer	0.064
grid 5x5 mm in the outlet plane of the nozzle	0.063
toothed ring placed in the outlet plane of the nozzle	0.057
toothed ring placed inside the cylindrical extension of the nozzle at the distance of $2d$ from the outlet plane	0.075

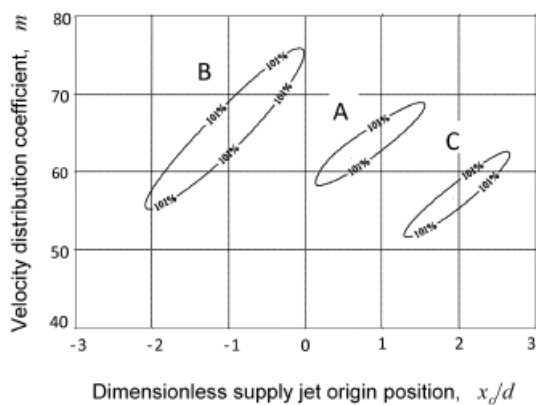

**Figure 8.**  
A map of approximation errors

the axial velocity value were neglected in the approximation.

Next, the approximation error was minimised in another way:  $m$  and  $x_o$  values were assumed and only  $I$  value was sought. The optimisation was carried out for all the combinations of the following  $m$  and  $x_o$  values:  $(m_{\Delta min} - 10) \leq (m_{\Delta min} + 10)$ ,  $(x_{o,\Delta min} - 1.5d) \leq x_o \leq (x_{o,\Delta min} + 1.5d)$ , with the step equal 2 and  $0.5d$ , respectively. Based on those results, a map of approximation errors as a function of  $m$  and  $x_o$  was generated by using a graphic computer code. All the tested cases are shown as one map of approximation error fields limited by a line of equal error  $\Delta/\Delta_{min} = 101\%$ , see Fig.8. The map gives information about  $m$  and  $x_o$  values, which describe the jets with high accuracy. It represents sensitivity of approximation to velocity distribution coefficient  $m$  and position of the origin  $x_o$ .

### Test results

In order to analyse the jet mean velocity distributions, jets from the following openings were tested:

– standard diffuser (in scale 1:1.75 ;  $W_o = 6\text{m/s}$ ), case A

– circular opening (in scale 1:5 ;  $W_o = 3.6\text{m/s}$ ), case B. The test results are shown in Fig. 8 as the areas A and B. The ranges of the origin distance ( $x_o$ ) and the velocity distribution coefficient ( $m$ ) are different for the standard diffuser and circular opening. However, when assuming the mean value of the velocity distribution coefficient as  $m=60$ , the difference in the jet origin position is about  $2d$ , i.e.:  $x_o = +0.5d$  for the standard diffuser and  $x_o = -1.5d$  for the circular opening. It suggests that similarity of jets may be acquired when the position of the jet origin is proper. In order to simulate the jet from the standard diffuser, circular openings with various turbulizers were tested. Based on the velocity distributions at the distance  $20d$  from the outlet plane, the velocity profiles widths were determined, see Table 2.

The toothed ring turbulizer placed inside the cylindrical extension of the nozzle at the distance of 2 from the outlet plane generated the turbulent jet at the widest spreading angle. The nozzle was used in further tests. The result of the tests is shown in Fig. 8 as area C. For  $m=60$  the origin position is  $x_o = 2.5d$ .

The test results show that it is possible to generate jets in which the origin position is the same as in case of jets generated by diffusers when nozzles with turbulizers are placed at the right position in reference to the wall. The nozzles should be put at the distance of  $2d$  before the wall (Fig. 9c).

## 5. THE EFFECT OF SUPPLY OPENING FITTING ON THE MEAN VELOCITY FIELD IN SCALE MODELS

In order to determine the effect of the supply opening fittings on the mean velocity field in the whole region of the flow modelled, air velocity measurement was carried out in the cross-sections of the models according to the method described in [2]. The measurement series data are as follows:



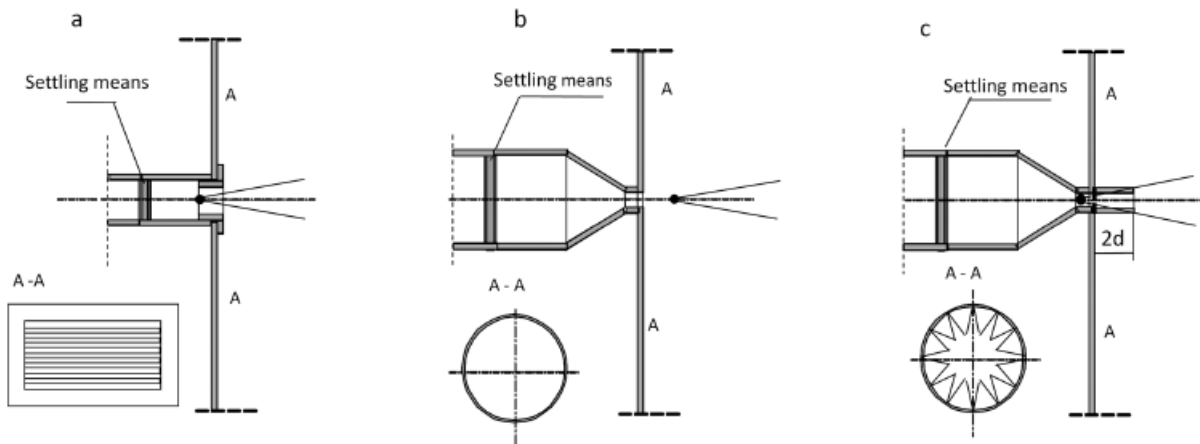

Figure 9. Various supply systems

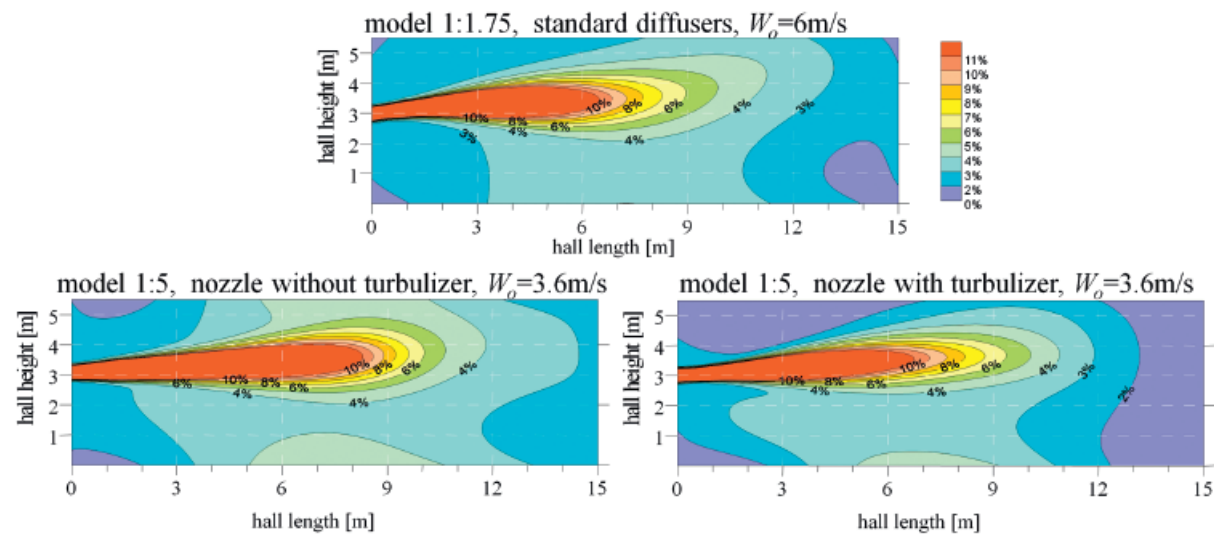

Figure 10. Comparison of results of three measurement series

1. model 1:1.75, supply from standard diffusers,  $W_o=6$  m/s (Fig. 9a)
2. model 1:5, supply from circular, nozzle openings,  $W_o=3.6$  m/s (Fig. 9b)
3. model 1:5, supply from circular opening with turbulizer,  $W_o=3.6$  m/s (Fig. 9c)

The test results are shown as normalised mean velocity isolines maps  $\bar{W}/W_o$  (Fig. 10).

Comparing the velocity map in the models: scale 1:1.75 with standard diffuser and scale 1:5 with circular, nozzle openings, considerable discrepancies in mean velocity fields both in the jet end whole modelled space are observed. The similarity of the veloc-

ity maps is much better when the standard diffuser is simulated by the circular nozzle fitted with turbulizers and when the jet origin is properly positioned. For the cases compared, quantitative correlation of normalised velocities was determined. Regression and correlation coefficients were calculated (Fig. 11). Fields of large velocity gradients close to the supply openings were neglected in the analysis.

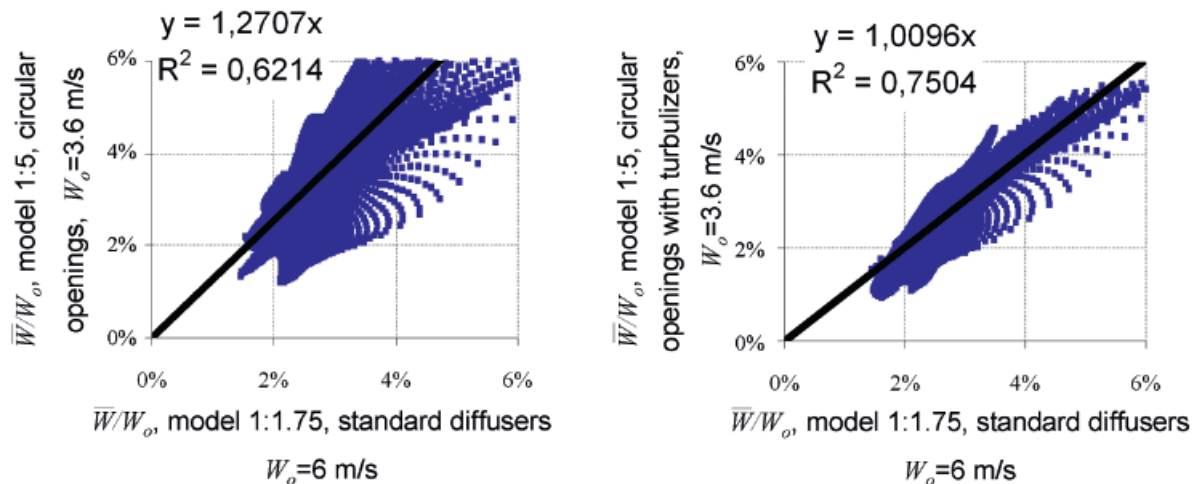

Figure 11. Convergence diagrams of the measurement series compared

## CONCLUSIONS

1. At Reynolds number higher than the threshold number  $Re_{rel}$  equal about 4 000 makes it possible to construct a physical scale model of ventilation in which approximate similarity of mean velocity distributions can be maintained in the whole area of the ventilating air flow pattern modelling, i.e. both in supply jets and in secondary flows.
2. The tests of turbulence structure reveal complexity and superposition of the flow phenomena and wide range of turbulence scales of ventilation flows. They show that it is possible to maintain similarity of turbulence spectrum in ventilation models when a second threshold Reynolds number,  $Re_2$ , is exceeded, the range of which can be defined as 10 000 to 20 000, depending on the required accuracy of the model analyses.
3. An improper supply air jets reproduction in scale models causes considerable mean velocity field distortions.
4. Satisfactory similarity of the air mean velocity field in the ventilated room and its models was acquired when real diffusers were simulated in the models by circular openings fitted with turbulizers and when the jet origin was properly positioned.
5. Obtained results can be applied in scale model experiments used in a ventilation design process of air distribution in large rooms and tests performed for CFD prediction validation.

## REFERENCES

- [1] Lipska B.; The Influence of the Localization of Outlets on the Air Distribution and the Propagation of Contaminants in Rooms with mixing Ventilation, Architecture Civil Engineering Environment, No 1/2009, p.129-136
- [2] Koper P., Lipska B., Michnol W.; Assessment of Thermal Comfort in an Indoor Swimming-pool Making Use of the Numerical Prediction CFD, Architecture Civil Engineering Environment, No 3/2010, p.37-45
- [3] Lipska B.; The Influence of the Localization of Outlets on the Air Distribution and the Propagation of Contaminants in Rooms with mixing Ventilation, Architecture Civil Engineering Environment, No 1/2009, p.129-136
- [4] Mierzwiński S. Popiołek Z. and Lipska B.; Experimental Verification and Improvement of Mathematical and Physical Methods of Ventilation Flows Modelling in Large Enclosures. KBN research report No 7 T07G 001 09, Silesian Technical University, Gliwice, 1998 (in Polish)
- [5] Kato S., Murakami S., Choi Nam Kong, Nakagawa H.; Model Experiment on Indoor Climate and Space Air Distribution in Large-Scale Room. Proceedings International Symposium on Scale Modelling, Tokio, 1988
- [6] Melikov A.K., Popiołek Z., Silva M.C.G., Care I., Seifker T.; Accuracy limitations for Low-Velocity Measurements and Draft Assessment in Rooms, HVAC&R Research, Vol.13, No 6, 2007, p.971-986
- [7] Etheridge D. and Sandberg M.; Building Ventilation: Theory and Measurement. John Wiley & Sons, Chichester, 1996

- [8] *Finkelstein W., Melikov A., Sefker T. and Langkilde G.;* Laser Doppler Measurement of Airflow Characteristics in Rooms with Mechanical Ventilation. Proc. of Indoor Air '96, Nagoya, Japan Vol.1, 1996, p.785-790
- [9] *Soehrich E.;* (1974) Self-similar turbulent flows in scale model tests of ventilation processes (in Polish). Dissertation, S.T.U. Gliwice, Poland
- [10] *Heiselberg P. and Murakami S. (editors);* Ventilation of Large Spaces in Buildings. Final report IEA-ECB&CS Annex 26. Chapter 2.5, 1996